

V8-270-E-A

1

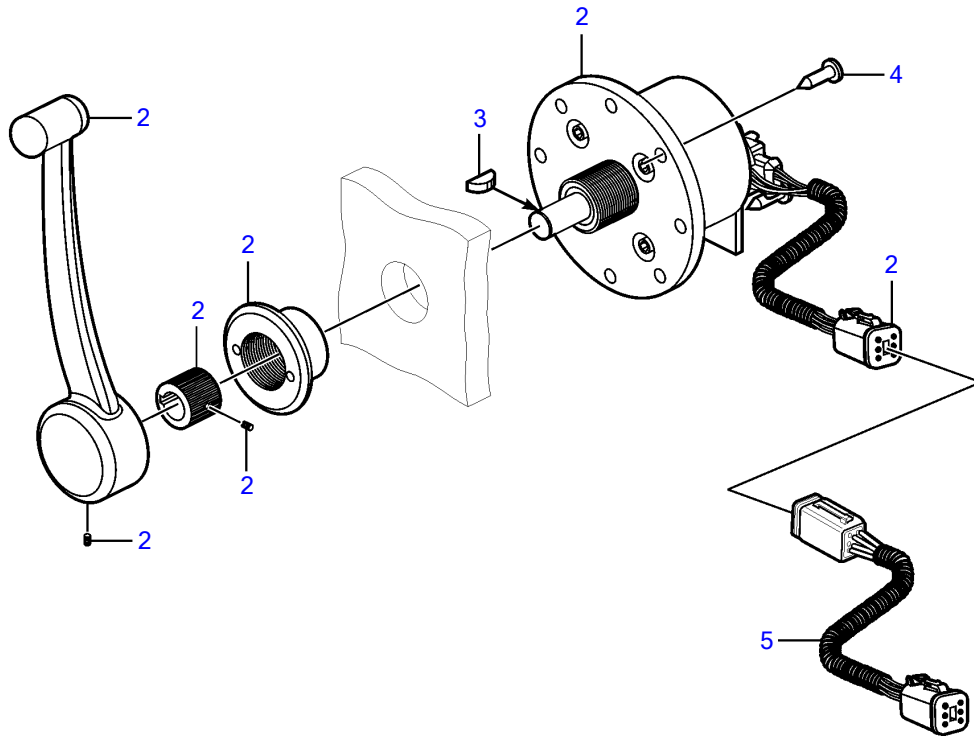

6

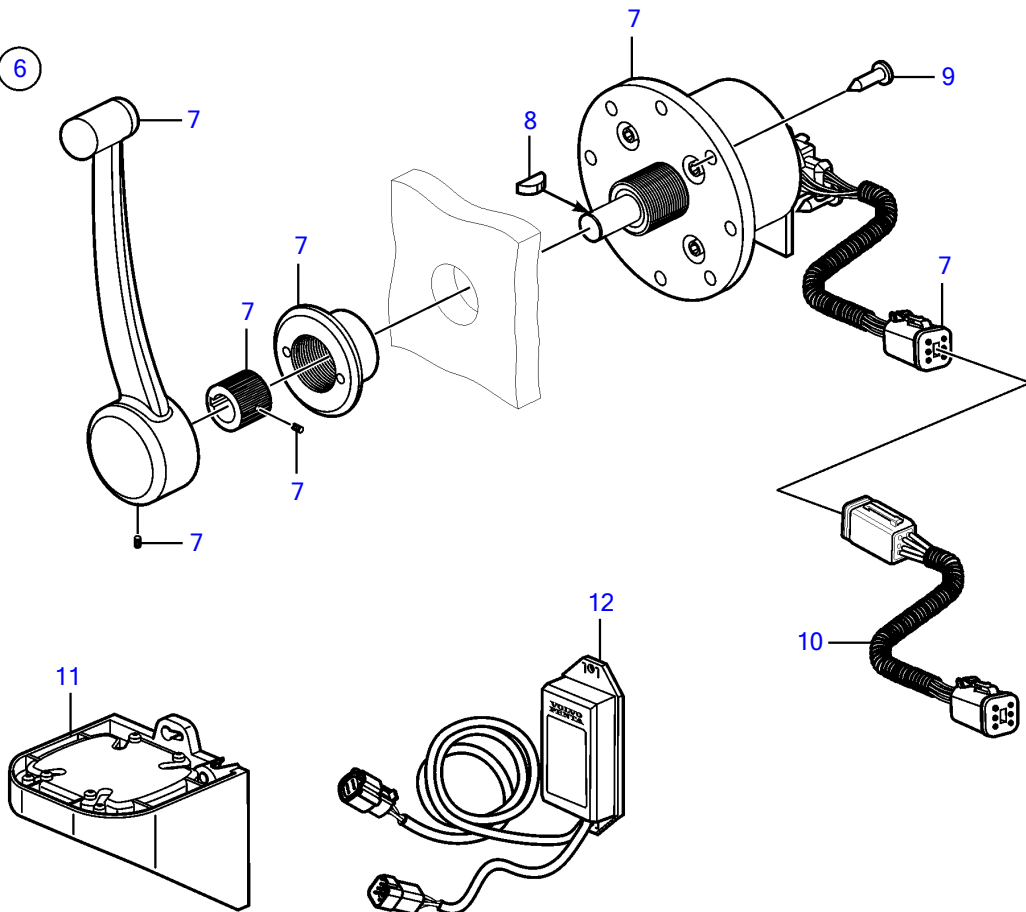

26045

V8-270-E-A

REF	PART NO.	QTY	DESCRIPTION	NOTES
1	21377436	1	Control, single	
2		1	• Control	Component parts not sold separately
3		1	• Key	part not sold
4		8	• Screw, stainless steel	¼" x 1", part not sold
5		1	• Cable	part not sold
6	3888616	1	Control, twin	
7		2	• Control	Component parts not sold separately
8		2	• Key	part not sold
9		16	• Screw, stainless steel	¼" x 1", part not sold
10		2	• Cable	part not sold
11	21520222	1	Control unit, HCU	to use earlier controls with EVC-D
12	21460908	1	Converter	Analog lever interface